



# Feuille de compétition / Competition Sheet

## European Champ. Grappling



STYLE : NOGI-M 60 kg

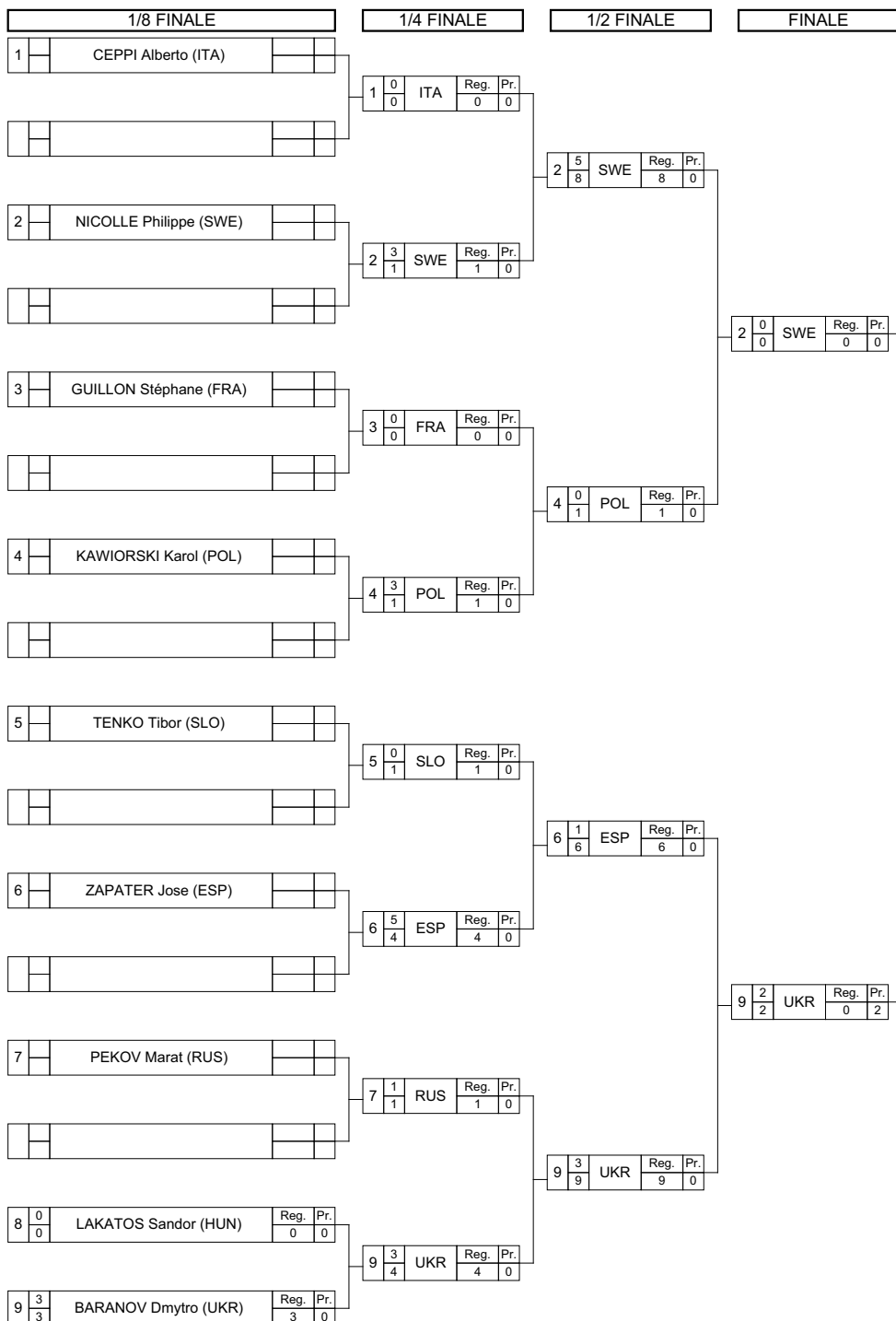

9 BARANOV Dmytro (UKR)

### Classement

Cl	Pays	Nom
1	UKR	BARANOV Dmytro
2	SWE	NICOLLE Philippe
3	ITA	CEPPI Alberto
3	ESP	ZAPATER Jose
5	POL	KAWIORSKI Karol
5	RUS	PEKOV Marat
7	HUN	LAKATOS Sandor
7	SLO	TENKO Tibor
9	FRA	GUILLON Stéphane

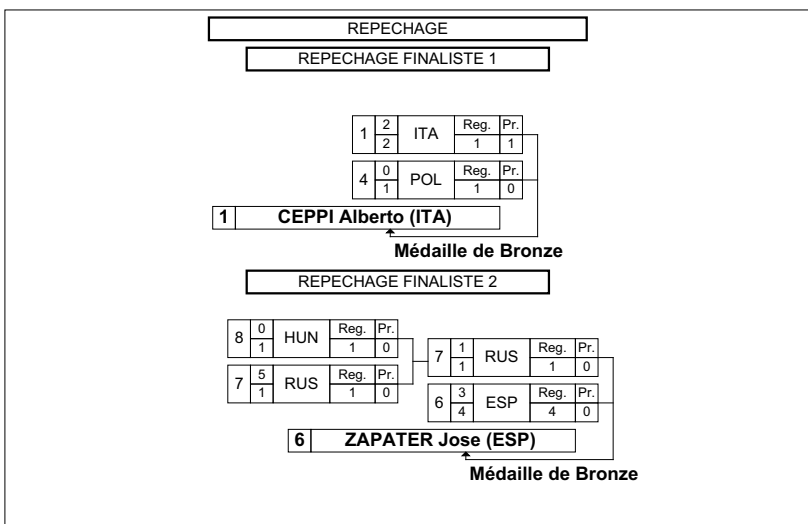



# Feuille de compétition / Competition Sheet

## European Champ. Grappling



STYLE : NOGI-M 65 kg



3 | **ALCALDE Francisco (ESP)**

### Classement

Cl	Pays	Nom
1	ESP	ALCALDE Francisco
2	POL	TRZCIONKA Robert
3	UKR	BEREST Vitaliy
3	FRA	JARDIN Mathias
5	ITA	SASSO DE OLIVEIRA M.
5	AZE	BABAYEV Agshin
7	CRO	MARJANOVIC Petar
8	SWE	SVENSSON Martin
9	RUS	BARAGUNOV Asker

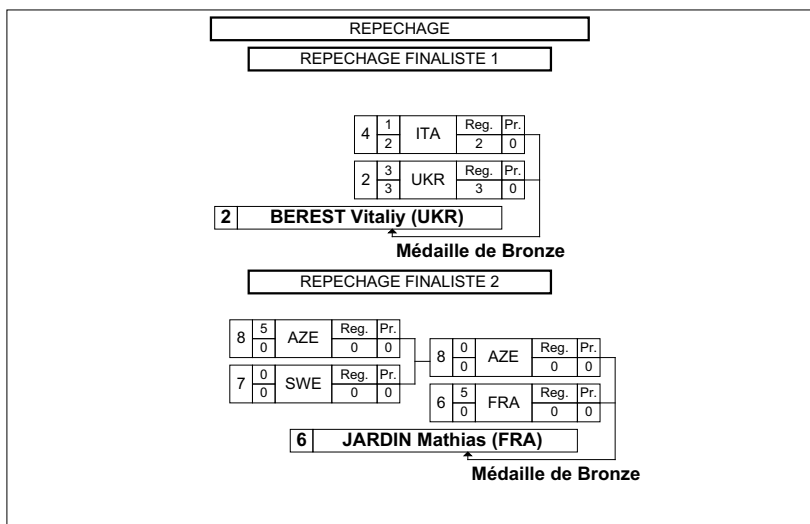



# Feuille de compétition / Competition Sheet

## European Champ. Grappling

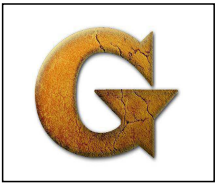

STYLE : NOGI-M 70 kg

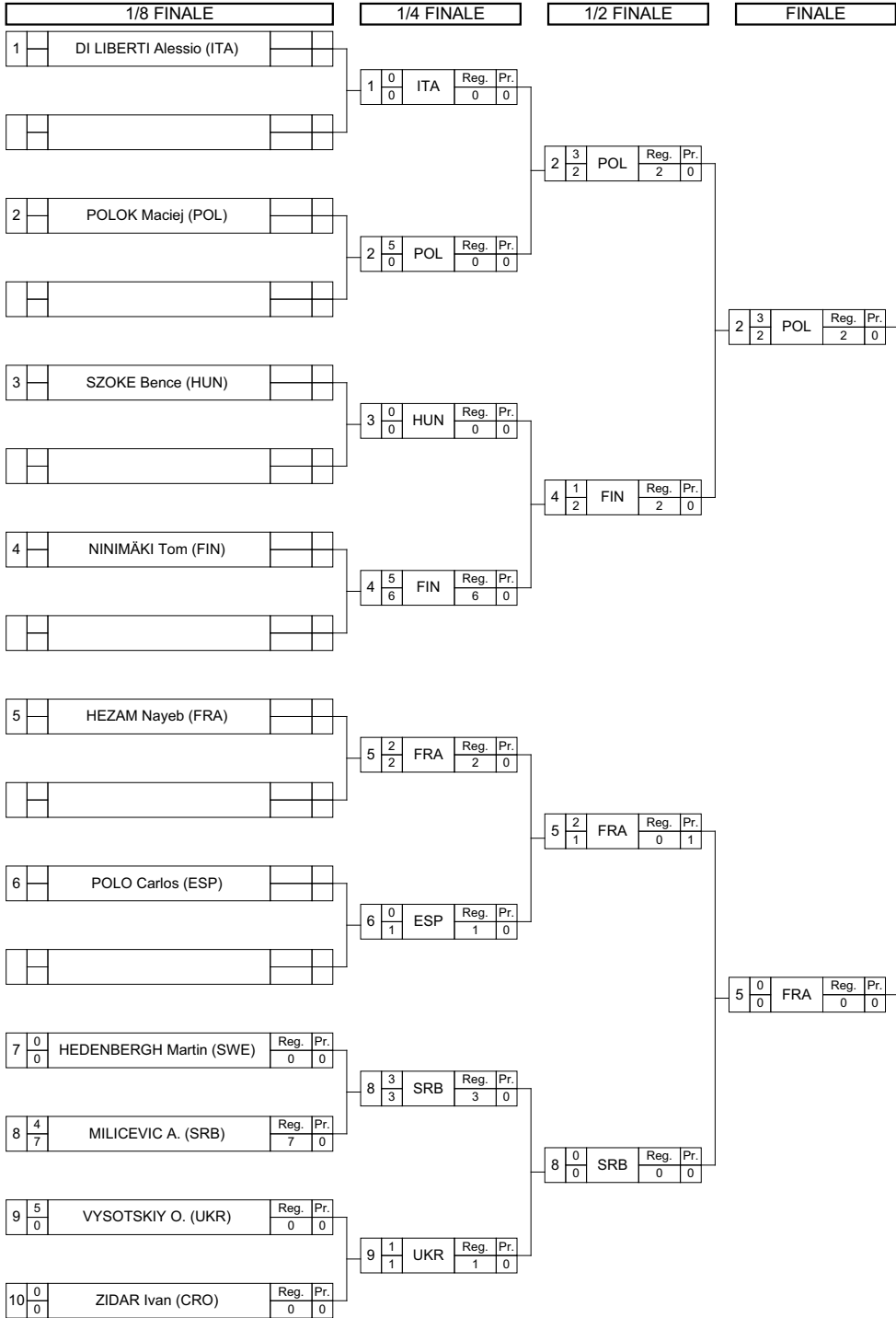

2 POLOK Maciej (POL)

Classement

Cl	Pays	Nom
1	POL	POLOK Maciej
2	FRA	HEZAM Nayeb
3	FIN	NINIMÄKI Tom
3	SRB	MILICEVIC A.
5	ITA	DI LIBERTI Alessio
5	ESP	POLO Carlos
7	UKR	VYSOTSKIY Oleksandr
8	CRO	ZIDAR Ivan
9	HUN	SZOKE Bence
10	SWE	HEDENBERGH Martin

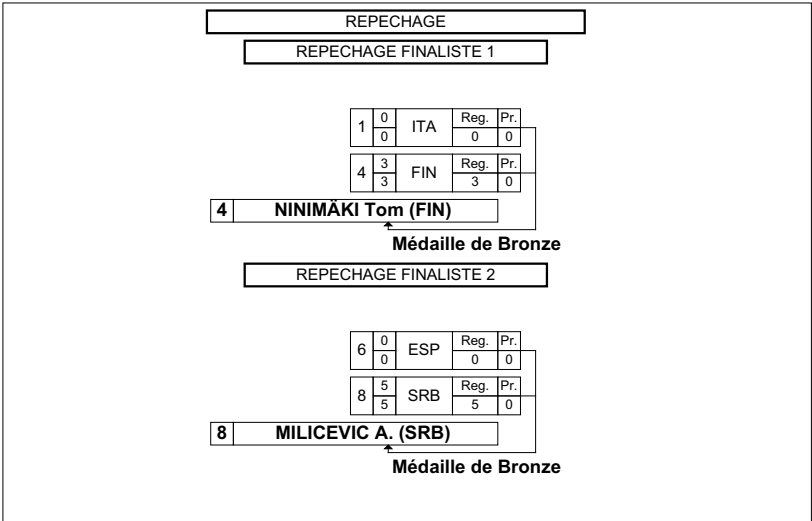



# Feuille de compétition / Competition Sheet

## European Champ. Grappling



STYLE : NOGI-M 75 kg

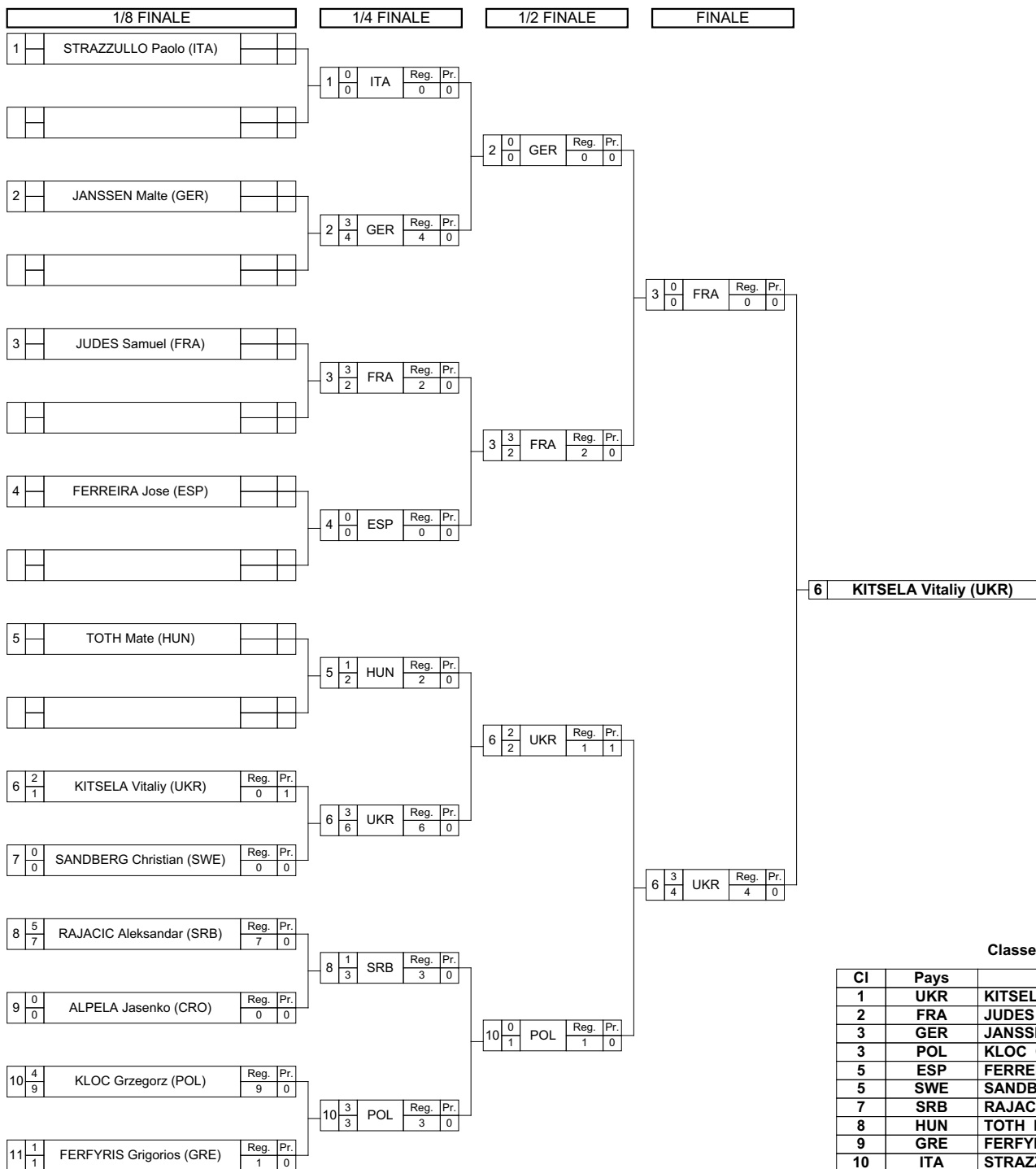

### Classement

Cl	Pays	Nom
1	UKR	KITSELA Vitaliy
2	FRA	JUDES Samuel
3	GER	JANSSEN Malte
3	POL	KLOC Grzegorz
5	ESP	FERREIRA Jose
5	SWE	SANDBERG Christian
7	SRB	RAJACIC Aleksandar
8	HUN	TOTH Mate
9	GRE	FERFYRIS Grigorios
10	ITA	STRAZZULLO Paolo
11	CRO	ALPELA Jasenko

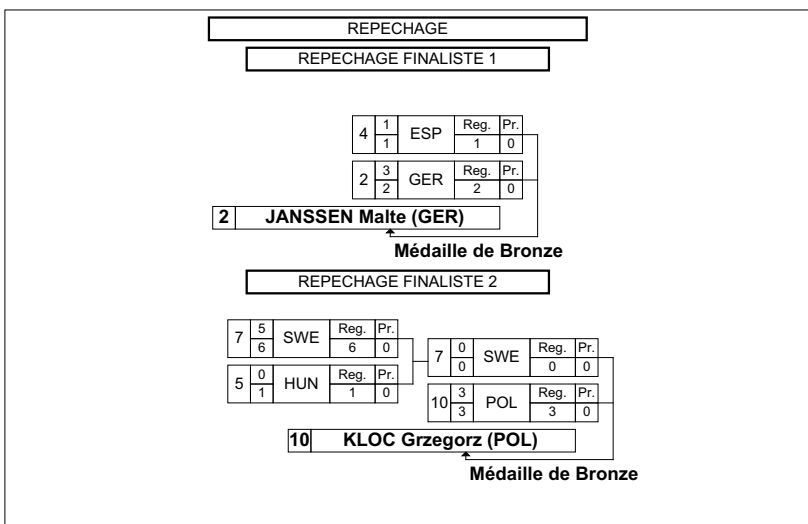



# Feuille de compétition / Competition Sheet

## European Champ. Grappling

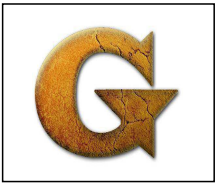

STYLE : NOGI-M 80 kg



7 LOUBERSANE Thomas (FRA)

Classement

Cl	Pays	Nom
1	FRA	LOUBERSANE Thomas
2	UKR	SERGIYENKO Sergiy
3	SWE	AWAD Mattias
3	POL	LUKASZEWICZ K.
5	GER	SEVIL Oren
5	GRE	VORRIAS Leontios
7	ITA	MASSARI Alessandro
8	HUN	BECZKAI Jenó
9	ESP	CAMPOS Miguel

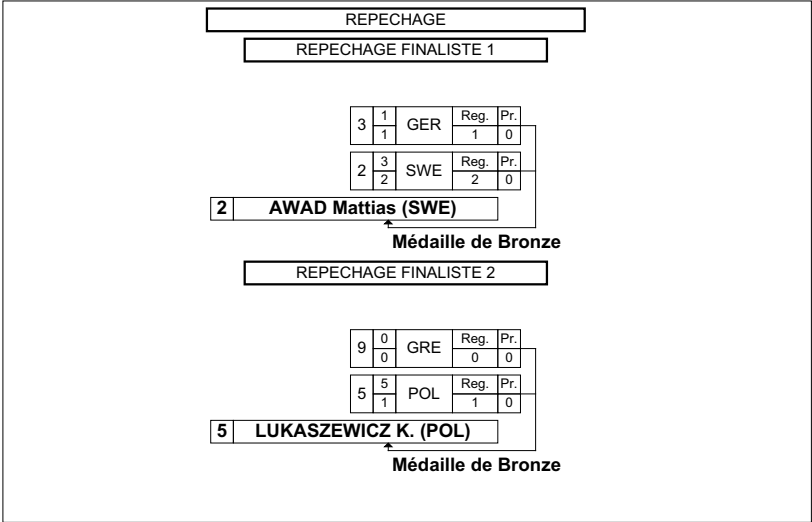



# Feuille de compétition / Competition Sheet

## European Champ. Grappling



STYLE : NOGI-M 90 kg

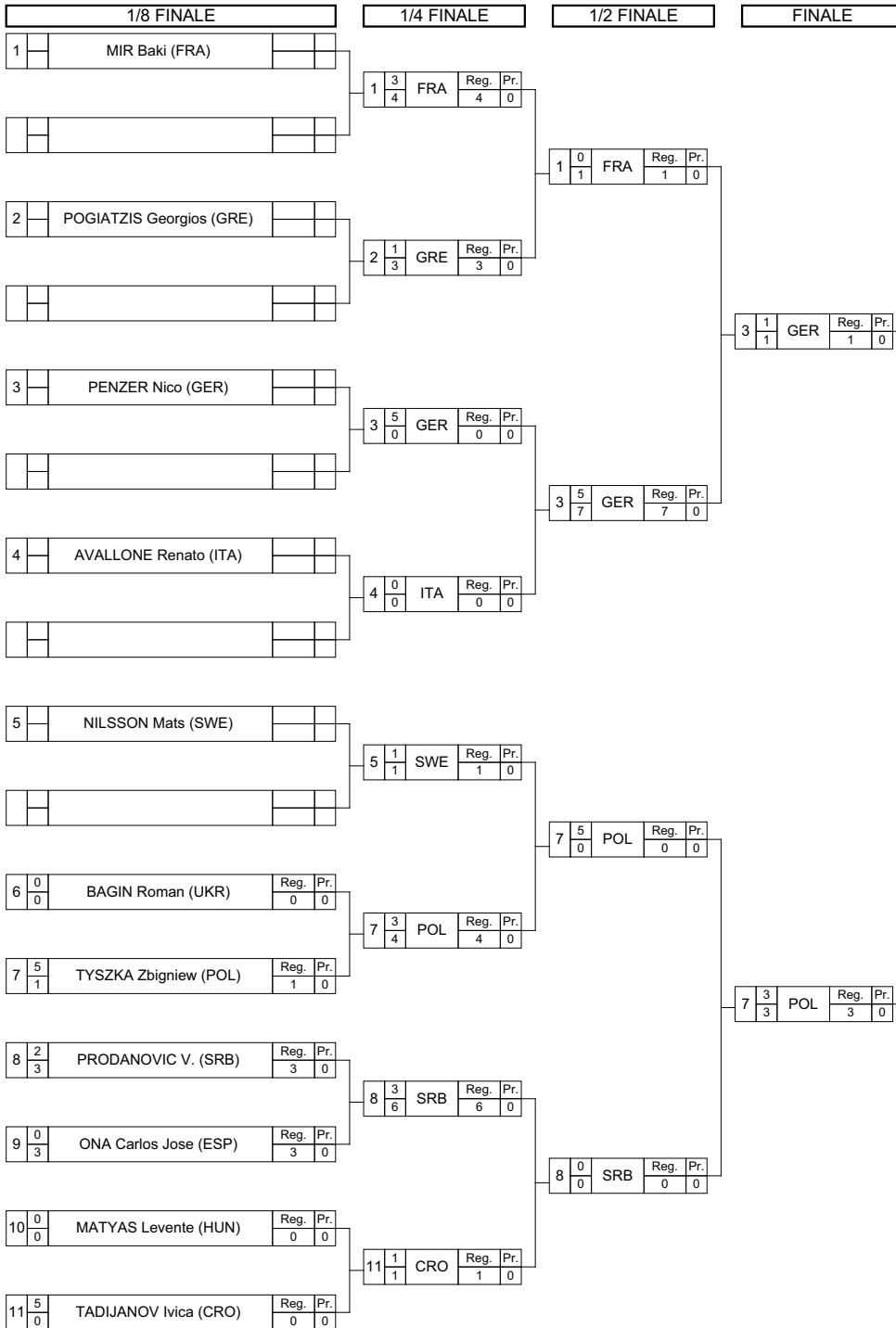

7 TYSZKA Zbigniew (POL)

### Classement

Cl	Pays	Nom
1	POL	TYSZKA Zbigniew
2	GER	PENZER Nico
3	ITA	AVALLONE Renato
3	SWE	NILSSON Mats
5	FRA	MIR Baki
5	SRB	PRODANOVIC Vladimir
7	CRO	TADIJANOV Ivica
8	GRE	POGIATZIS Georgios
9	ESP	ONA Carlos Jose
10	UKR	BAGIN Roman
11	HUN	MATYAS Levente

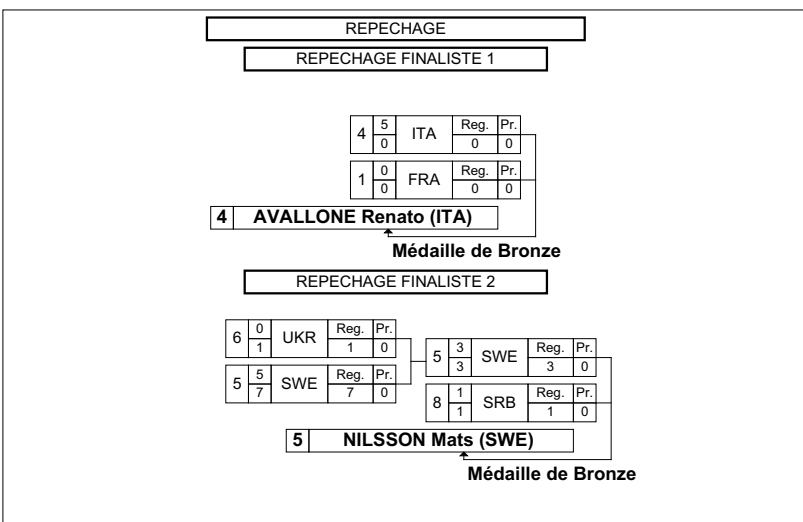



# Feuille de compétition / Competition Sheet

## European Champ. Grappling



STYLE : NOGI-M 110 kg



### Classement

Cl	Pays	Nom
1	CRO	PILIPOVIC Vlado
2	POL	SZATKOWSKI Grzegorz
3	UKR	MUSLIDINOV Renat
3	HUN	KALMAR Istvan
5	GER	PETRAJIDIS A.
5	FRA	ROMMING Johan
7	MNE	RADOSAVLJEVIC V.
8	SRB	KLISARIC Srdjan
9	SWE	KNUTSSON Mikael

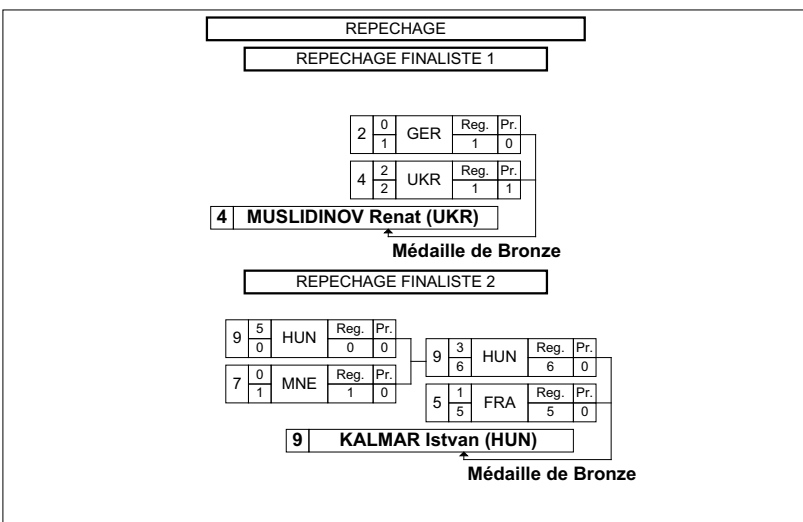



# Feuille de compétition / Competition Sheet

## European Champ. Grappling



STYLE : NOGI-M Abs kg

QUALIFICATION				1/8 FINALE				1/4 FINALE				1/2 FINALE				FINALE			
1		KLISARIC Srdjan (SRB)		1	5/2	SRB	Reg. Pr. 2 0	1	0/0	SRB	Reg. Pr. 0 0	4	5/3	CRO	Reg. Pr. 3 0	4	1/2	CRO	Reg. Pr. 2 0
2		GULYAS Csaba (HUN)		2	0/0	HUN	Reg. Pr. 0 0	2	0/0	HUN	Reg. Pr. 0 0	5	1/2	SWE	Reg. Pr. 2 0	6	0/0	MNE	Reg. Pr. 0 0
3		KALMAR Istvan (HUN)		3	0/0	HUN	Reg. Pr. 0 0	3	0/0	HUN	Reg. Pr. 0 0	6	3/3	MNE	Reg. Pr. 3 0	7	0/0	ESP	Reg. Pr. 0 0
4		TADIJANOV Ivica (CRO)		4	5/0	CRO	Reg. Pr. 0 0	4	3/1	CRO	Reg. Pr. 1 0	7	5/1	ESP	Reg. Pr. 1 0	7	5/0	ESP	Reg. Pr. 0 0
5		ANDERSSON Johan (SWE)		5	1/2	SWE	Reg. Pr. 2 0	7	0/3	ITA	Reg. Pr. 3 0	8	0/0	ITA	Reg. Pr. 0 0	10	5/0	UKR	Reg. Pr. 0 0
6		RADOSAVSEVIC V. (MNE)		6	3/3	MNE	Reg. Pr. 3 0	8	0/0	ITA	Reg. Pr. 0 0	10	5/1	UKR	Reg. Pr. 1 0	10	0/0	UKR	Reg. Pr. 0 0
7		GONZALEZ Alberto (ESP)		7	5/1	ESP	Reg. Pr. 1 0	11	0/0	GRE	Reg. Pr. 0 0	12	0/0	CRO	Reg. Pr. 0 0	14	5/0	POL	Reg. Pr. 0 0
8		STRAZZULLO Paolo (ITA)		8	0/3	ITA	Reg. Pr. 3 0	12	5/0	CRO	Reg. Pr. 0 0	14	5/3	POL	Reg. Pr. 3 0	15	5/0	POL	Reg. Pr. 0 0
9		MASSARI Alessandro (ITA)		9	0/0	ITA	Reg. Pr. 0 0	13	0/0	GRE	Reg. Pr. 0 0	15	0/4	FRA	Reg. Pr. 4 0	15	0/0	POL	Reg. Pr. 0 0
10		MUSLIDINOV Renat (UKR)		10	5/1	UKR	Reg. Pr. 1 0	13	0/0	GRE	Reg. Pr. 0 0	17	0/0	FRA	Reg. Pr. 0 0	17	0/0	POL	Reg. Pr. 0 0
11		POGIATZIS Georgios (GRE)		11	0/0	GRE	Reg. Pr. 0 0	14	5/0	POL	Reg. Pr. 0 0	18	0/2	RAJACIC Aleksandar (SRB)	Reg. Pr. 2 0				
12		ERKAPIC Miro (CRO)		12	5/0	CRO	Reg. Pr. 0 0	15	0/0	POL	Reg. Pr. 0 0								
13		VORRIAS Leontios (GRE)		13	0/0	GRE	Reg. Pr. 0 0												
14		LACH Wojciech (POL)		14	5/3	POL	Reg. Pr. 3 0												
15	5/0	TYSZKA Zbigniew (POL)	Reg. Pr. 0 0	15	5/0	POL	Reg. Pr. 0 0												
16	0/1	FERREIRA Jose (ESP)	Reg. Pr. 1 0	17	0/0	FRA	Reg. Pr. 0 0												
17	4/4	ROMMING Johan (FRA)	Reg. Pr. 4 0																
18	0/2	RAJACIC Aleksandar (SRB)	Reg. Pr. 2 0																

14 LACH Wojciech (POL)

### Classement

Cl	Pays	Nom
1	POL	LACH Wojciech
2	CRO	TADIJANOV Ivica
3	HUN	KALMAR Istvan
3	POL	TYSZKA Zbigniew
5	ESP	GONZALEZ Alberto
5	UKR	MUSLIDINOV Renat
7	SRB	KLISARIC Srdjan
8	CRO	ERKAPIC Miro
9	FRA	ROMMING Johan
10	MNE	RADOSAVSEVIC V.
11	SWE	ANDERSSON Johan
12	ITA	STRAZZULLO Paolo
13	SRB	RAJACIC Aleksandar
14	ESP	FERREIRA Jose
15	GRE	POGIATZIS Georgios
16	ITA	MASSARI Alessandro
17	HUN	GULYAS Csaba
18	GRE	VORRIAS Leontios

### REPECHAGE

#### REPECHAGE FINALISTE 1

3	3/3	HUN	Reg. Pr. 3 0	3	5/1	HUN	Reg. Pr. 1 0
1	1/2	SRB	Reg. Pr. 2 0	7	0/0	ESP	Reg. Pr. 0 0

3 KALMAR Istvan (HUN)

Médaille de Bronze

#### REPECHAGE FINALISTE 2

13	0/0	GRE	Reg. Pr. 0 0	15	5/0	POL	Reg. Pr. 0 0
15	5/3	POL	Reg. Pr. 3 0	10	0/0	UKR	Reg. Pr. 0 0

15 TYSZKA Zbigniew (POL)

Médaille de Bronze



# Feuille de compétition / Competition Sheet

## European Champ. Grappling

STYLE : NOGI-W 50 kg



### TOUR : 1

1	3	HAMMARSTEN Anny (SWE)	Reg	Pr.	1	HAMMARSTEN Anny (SWE)
	2		2	0		
2	1	SOLA Marija (CRO)	Reg	Pr.	2	
	1		1	0		
3	5	GALKA Joanna (POL)	Reg	Pr.	3	GALKA Joanna (POL)
	2		2	0		
4	0	PIGULYAK Svitlana (UKR)	Reg	Pr.	4	
	1		1	0		

### TOUR : 2

5	0	ROMANI Marta (ITA)	Reg	Pr.	5	1	HAMMARSTEN Anny (SWE)
	0		0	0			
1	5	HAMMARSTEN Anny (SWE)	Reg	Pr.	1		
	0		0	0			
2	4	SOLA Marija (CRO)	Reg	Pr.	2	2	SOLA Marija (CRO)
	10		10	0			
3	0	GALKA Joanna (POL)	Reg	Pr.	3		
	0		0	0			

### TOUR : 3

4	0	PIGULYAK Svitlana (UKR)	Reg	Pr.	4	1	HAMMARSTEN Anny (SWE)
	1		1	0			
1	5	HAMMARSTEN Anny (SWE)	Reg	Pr.	1		
	4		4	0			
5	0	ROMANI Marta (ITA)	Reg	Pr.	5	2	SOLA Marija (CRO)
	0		0	0			
2	3	SOLA Marija (CRO)	Reg	Pr.	2		
	2		2	0			

### TOUR : 4

3	0	GALKA Joanna (POL)	Reg	Pr.	3	1	HAMMARSTEN Anny (SWE)
	0		0	0			
1	3	HAMMARSTEN Anny (SWE)	Reg	Pr.	1		
	1		1	0			
4	5	PIGULYAK Svitlana (UKR)	Reg	Pr.	4	4	PIGULYAK Svitlana (UKR)
	7		7	0			
5	0	ROMANI Marta (ITA)	Reg	Pr.	5		
	0		0	0			

### TOUR : 5

2	5	SOLA Marija (CRO)	Reg	Pr.	2	2	SOLA Marija (CRO)
	1		1	0			
4	0	PIGULYAK Svitlana (UKR)	Reg	Pr.	4		
	0		0	0			
3	2	GALKA Joanna (POL)	Reg	Pr.	3	3	GALKA Joanna (POL)
	1		0	1			
5	0	ROMANI Marta (ITA)	Reg	Pr.	5		
	1		1	0			

### Classement

Cl	Pays	Nom	Points
1	SWE	HAMMARSTEN Anny	16
2	CRO	SOLA Marija	13
3	POL	GALKA Joanna	7
4	UKR	PIGULYAK Svitlana	5
5	ITA	ROMANI Marta	0



# Feuille de compétition / Competition Sheet

## European Champ. Grappling

STYLE : NOGI-W 55 kg



### TOUR : 1

1	$\frac{0}{1}$	JANSSON Annica (SWE)	Reg	Pr.	2	KUZMENKO Tetyana (UKR)
			1	0		
2	$\frac{5}{0}$	KUZMENKO Tetyana (UKR)	Reg	Pr.		
			0	0		
3	$\frac{3}{4}$	PASZKIEWICZ Sandra (POL)	Reg	Pr.	3	PASZKIEWICZ Sandra (POL)
			4	0		
4	$\frac{1}{1}$	OLBERT Elisabeth (AUT)	Reg	Pr.		
			1	0		

### TOUR : 2

5	$\frac{5}{0}$	TALVARD Océane (FRA)	Reg	Pr.	5	TALVARD Océane (FRA)
			0	0		
1	$\frac{0}{0}$	JANSSON Annica (SWE)	Reg	Pr.		
			0	0		
2	$\frac{1}{2}$	KUZMENKO Tetyana (UKR)	Reg	Pr.	3	PASZKIEWICZ Sandra (POL)
			2	0		
3	$\frac{3}{4}$	PASZKIEWICZ Sandra (POL)	Reg	Pr.		
			4	0		

### TOUR : 3

4	$\frac{5}{6}$	OLBERT Elisabeth (AUT)	Reg	Pr.	4	OLBERT Elisabeth (AUT)
			6	0		
1	$\frac{0}{0}$	JANSSON Annica (SWE)	Reg	Pr.		
			0	0		
5	$\frac{3}{8}$	TALVARD Océane (FRA)	Reg	Pr.	5	TALVARD Océane (FRA)
			8	0		
2	$\frac{1}{2}$	KUZMENKO Tetyana (UKR)	Reg	Pr.		
			2	0		

### TOUR : 4

3	$\frac{5}{7}$	PASZKIEWICZ Sandra (POL)	Reg	Pr.	3	PASZKIEWICZ Sandra (POL)
			7	0		
1	$\frac{0}{1}$	JANSSON Annica (SWE)	Reg	Pr.		
			1	0		
4	$\frac{0}{0}$	OLBERT Elisabeth (AUT)	Reg	Pr.	5	TALVARD Océane (FRA)
			0	0		
5	$\frac{3}{3}$	TALVARD Océane (FRA)	Reg	Pr.		
			3	0		

### TOUR : 5

2	$\frac{1}{2}$	KUZMENKO Tetyana (UKR)	Reg	Pr.	4	OLBERT Elisabeth (AUT)
			2	0		
4	$\frac{3}{8}$	OLBERT Elisabeth (AUT)	Reg	Pr.		
			8	0		
3	$\frac{0}{0}$	PASZKIEWICZ Sandra (POL)	Reg	Pr.	5	TALVARD Océane (FRA)
			0	0		
5	$\frac{3}{2}$	TALVARD Océane (FRA)	Reg	Pr.		
			2	0		

### Classement

Cl	Pays	Nom	Points
1	FRA	TALVARD Océane	14
2	POL	PASZKIEWICZ Sandra	11
3	AUT	OLBERT Elisabeth	9
4	UKR	KUZMENKO Tetyana	8
5	SWE	JANSSON Annica	0



# Feuille de compétition / Competition Sheet

## European Champ. Grappling

STYLE : NOGI-W 60 kg



### TOUR : 1

1	5 1	SYNIAVINA V. (UKR)	Reg 1	Pr. 0	1	SYNIAVINA V. (UKR)
2	0 0	KRCMAREVIC Andjela (SRB)	Reg 0	Pr. 0		
3	0 1	HANSSON Ida (SWE)	Reg 1	Pr. 0	4	PREISS Irena (POL)
4	5 0	PREISS Irena (POL)	Reg 0	Pr. 0		

### TOUR : 2

1	0 1	SYNIAVINA V. (UKR)	Reg 1	Pr. 0	3	HANSSON Ida (SWE)
3	5 4	HANSSON Ida (SWE)	Reg 4	Pr. 0		
2	0 0	KRCMAREVIC Andjela (SRB)	Reg 0	Pr. 0	4	PREISS Irena (POL)
4	5 0	PREISS Irena (POL)	Reg 0	Pr. 0		

### TOUR : 3

1	1 1	SYNIAVINA V. (UKR)	Reg 1	Pr. 0	4	PREISS Irena (POL)
4	3 5	PREISS Irena (POL)	Reg 5	Pr. 0		
2	0 0	KRCMAREVIC Andjela (SRB)	Reg 0	Pr. 0	3	HANSSON Ida (SWE)
3	5 6	HANSSON Ida (SWE)	Reg 6	Pr. 0		

### Classement

Cl	Pays	Nom	Points
1	POL	PREISS Irena	13
2	SWE	HANSSON Ida	10
3	UKR	SYNIAVINA Viktoriya	6
4	SRB	KRCMAREVIC Andjela	0



# Feuille de compétition / Competition Sheet

## European Champ. Grappling

STYLE : NOGI-W 65 kg



### TOUR : 1

1	$\frac{3}{6}$	ZAWODNIK Karolina (POL)	Reg	Pr.	1	ZAWODNIK Karolina (POL)
			6	0		
2	$\frac{0}{0}$	HJÄRN Johanna (SWE)	Reg	Pr.		
			0	0		

### TOUR : 2

3	$\frac{0}{0}$	DAVYDOVA Margaryta (UKR)	Reg	Pr.	1	ZAWODNIK Karolina (POL)
			0	0		
1	$\frac{5}{1}$	ZAWODNIK Karolina (POL)	Reg	Pr.		
			1	0		

### TOUR : 3

2	$\frac{3}{4}$	HJÄRN Johanna (SWE)	Reg	Pr.	2	HJÄRN Johanna (SWE)
			4	0		
3	$\frac{0}{0}$	DAVYDOVA Margaryta (UKR)	Reg	Pr.		
			0	0		

### Classement

Cl	Pays	Nom	Points
1	POL	ZAWODNIK Karolina	8
2	SWE	HJÄRN Johanna	3
3	UKR	DAVYDOVA Margaryta	0



# Feuille de compétition / Competition Sheet

## European Champ. Grappling

STYLE : NOGI-W 75 kg



### TOUR : 1

1	$\frac{0}{0}$	MATEYCHUK Galyna (UKR)	Reg	Pr.	2	RUYSEN Romy (FRA)
			0	0		
2	$\frac{5}{0}$	RUYSEN Romy (FRA)	Reg	Pr.		
			0	0		

### TOUR : 2

3	$\frac{5}{5}$	DZWIGALOWSKA J. (POL)	Reg	Pr.	3	DZWIGALOWSKA J. (POL)
			5	0		
1	$\frac{0}{0}$	MATEYCHUK Galyna (UKR)	Reg	Pr.		
			0	0		

### TOUR : 3

2	$\frac{5}{0}$	RUYSEN Romy (FRA)	Reg	Pr.	2	RUYSEN Romy (FRA)
			0	0		
3	$\frac{0}{1}$	DZWIGALOWSKA J. (POL)	Reg	Pr.		
			1	0		

### Classement

Cl	Pays	Nom	Points
1	FRA	RUYSEN Romy	10
2	POL	DZWIGALOWSKA Joanna	5
3	UKR	MATEYCHUK Galyna	0





# Feuille de compétition / Competition Sheet

## European Champ. Grappling

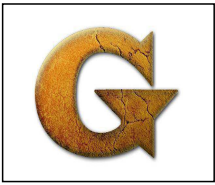

STYLE : GI-M 65 kg

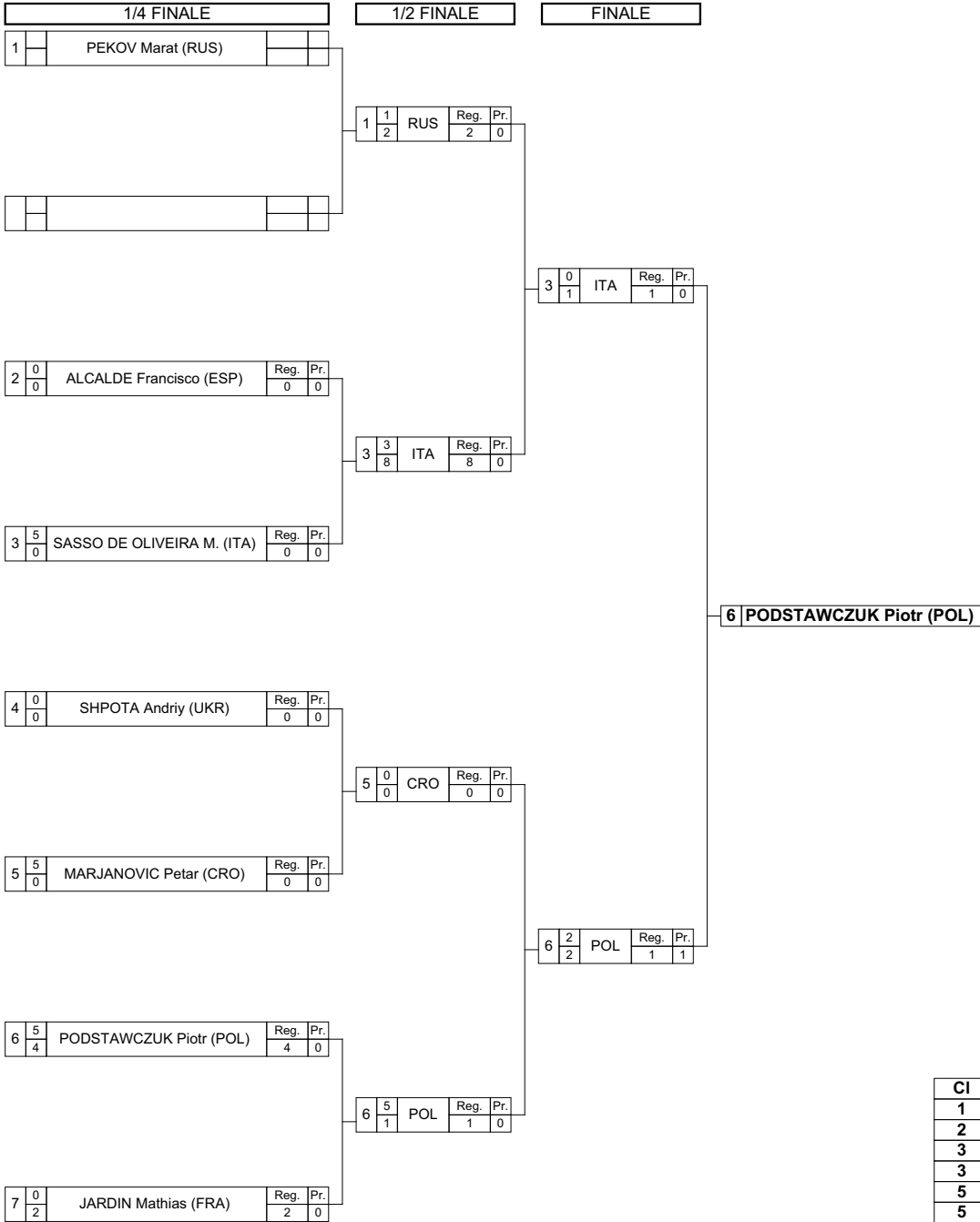

### Classement

Cl	Pays	Nom
1	POL	PODSTAWCZUK Piotr
2	ITA	SASSO DE OLIVEIRA M.
3	RUS	PEKOV Marat
3	FRA	JARDIN Mathias
5	ESP	ALCALDE Francisco
5	CRO	MARJANOVIC Petar
7	UKR	SHPOTA Andriy
7	ESP	ALCALDE Francisco

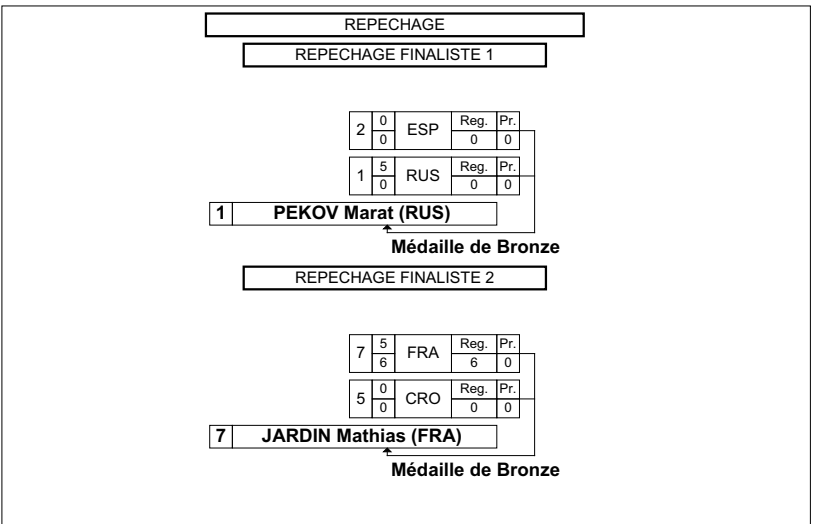



# Feuille de compétition / Competition Sheet

## European Champ. Grappling

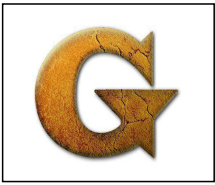

STYLE : GI-M 70 kg



Classement

Cl	Pays	Nom
1	POL	POLOK Maciej
2	SRB	MILICEVIC A.
3	HUN	SZOKE Bence
3	ITA	DI LIBERTI Alessio
5	ESP	POLO Carlos
5	CRO	ZIDAR Ivan
7	FRA	HEZAM Nayeb

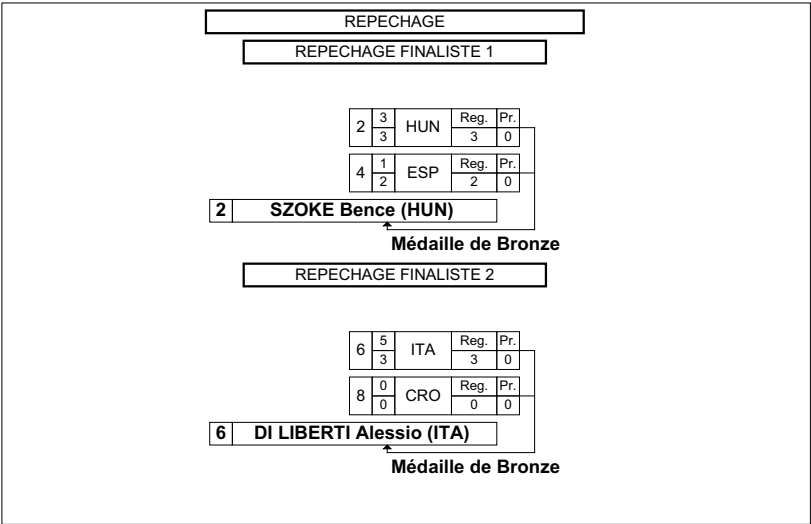



# Feuille de compétition / Competition Sheet

## European Champ. Grappling

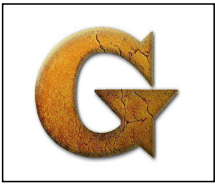

STYLE : GI-M 75 kg



Classement

Cl	Pays	Nom
1	POL	KLOC Grzegorz
2	UKR	TYUPIN Andriy
3	FRA	JUDES Samuel
3	ITA	STRAZZULLO Paolo
5	ESP	FERREIRA Jose
5	CRO	ALPEZA Jasenko
7	SRB	RAJACIC Aleksandar
8	HUN	TOTH Mate

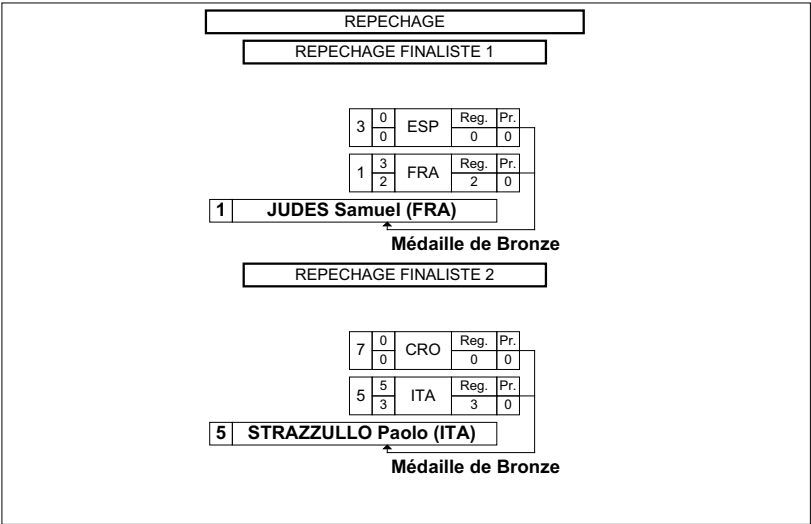



# Feuille de compétition / Competition Sheet

## European Champ. Grappling

STYLE : GI-M 80 kg



### TOUR : 1

1	$\frac{5}{0}$	MICHALOWSKI Tomasz (POL)	Reg	Pr.	1 MICHALOWSKI Tomasz (POL)
			0	0	
2	$\frac{0}{0}$	CAMPOS Miguel (ESP)	Reg	Pr.	
			0	0	
3	$\frac{0}{0}$	LOUBERSANE Thomas (FRA)	Reg	Pr.	4 AGAFONOV Oleksandr (UKR)
			0	0	
4	$\frac{5}{0}$	AGAFONOV Oleksandr (UKR)	Reg	Pr.	
			0	0	

### TOUR : 2

1	$\frac{5}{0}$	MICHALOWSKI Tomasz (POL)	Reg	Pr.	1 MICHALOWSKI Tomasz (POL)
			0	0	
3	$\frac{0}{0}$	LOUBERSANE Thomas (FRA)	Reg	Pr.	
			0	0	
2	$\frac{2}{1}$	CAMPOS Miguel (ESP)	Reg	Pr.	2 CAMPOS Miguel (ESP)
			0	1	
4	$\frac{0}{0}$	AGAFONOV Oleksandr (UKR)	Reg	Pr.	
			0	0	

### TOUR : 3

1	$\frac{3}{7}$	MICHALOWSKI Tomasz (POL)	Reg	Pr.	1 MICHALOWSKI Tomasz (POL)
			7	0	
4	$\frac{1}{1}$	AGAFONOV Oleksandr (UKR)	Reg	Pr.	
			1	0	
2	$\frac{5}{0}$	CAMPOS Miguel (ESP)	Reg	Pr.	2 CAMPOS Miguel (ESP)
			0	0	
3	$\frac{0}{0}$	LOUBERSANE Thomas (FRA)	Reg	Pr.	
			0	0	

### Classement

Cl	Pays	Nom	Points
1	POL	MICHALOWSKI Tomasz	13
2	ESP	CAMPOS Miguel	7
3	UKR	AGAFONOV Oleksandr	6
4	FRA	LOUBERSANE Thomas	0



# Feuille de compétition / Competition Sheet

## European Champ. Grappling

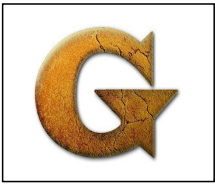

STYLE : GI-M 90 kg

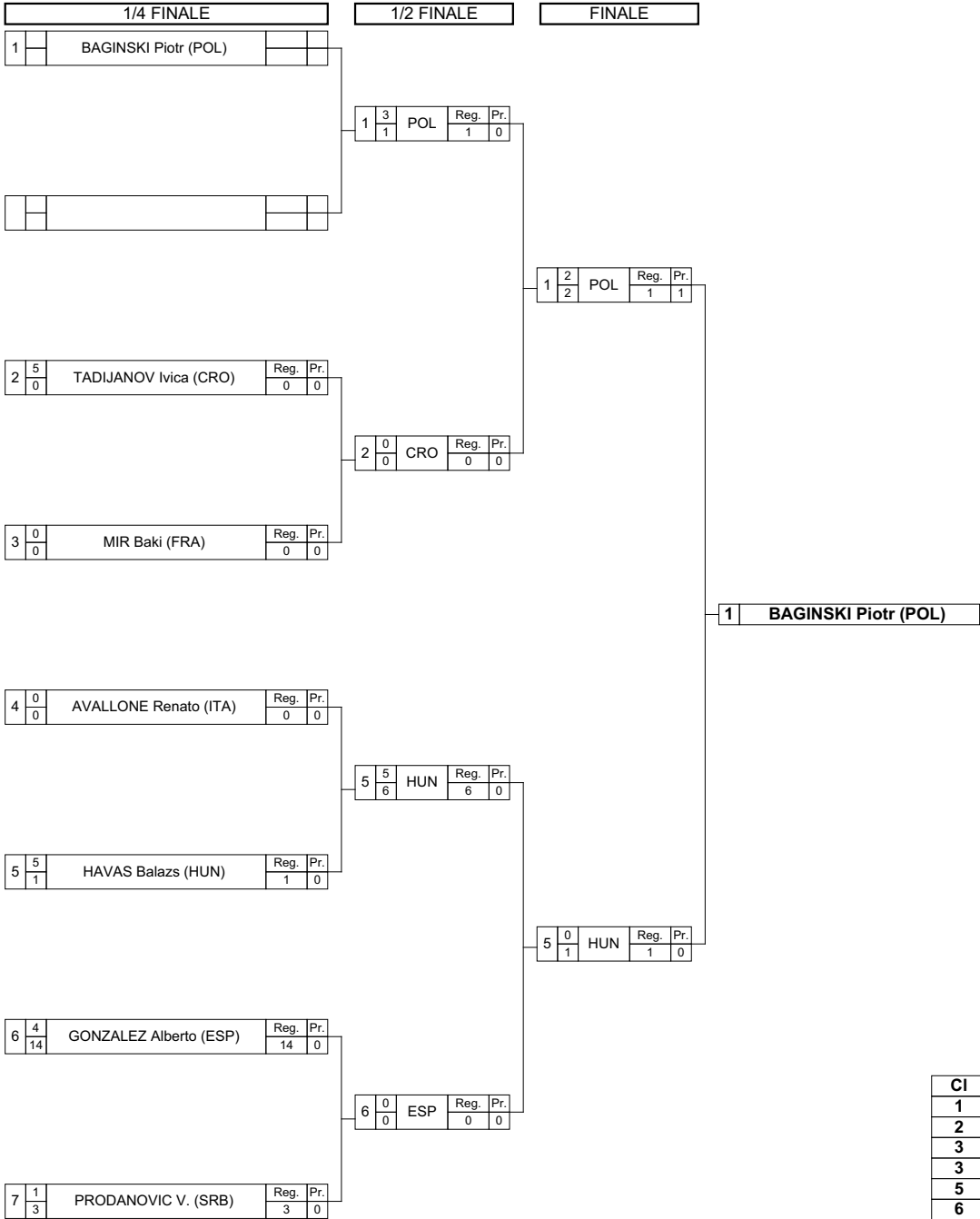

**Classement**

Cl	Pays	Nom
1	POL	BAGINSKI Piotr
2	HUN	HAVAS Balazs
3	CRO	TADIJANOV Ivica
3	ESP	GONZALEZ Alberto
5	ITA	AVALLONE Renato
6	SRB	PRODANOVIC Vladimir
7	FRA	MIR Baki

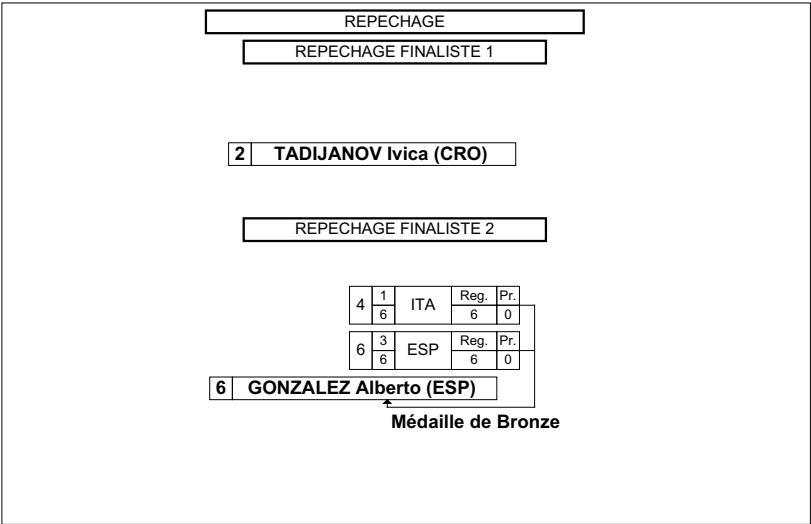



# Feuille de compétition / Competition Sheet

## European Champ. Grappling

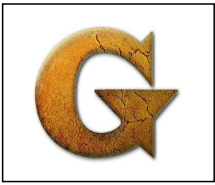

STYLE : GI-M 110 kg

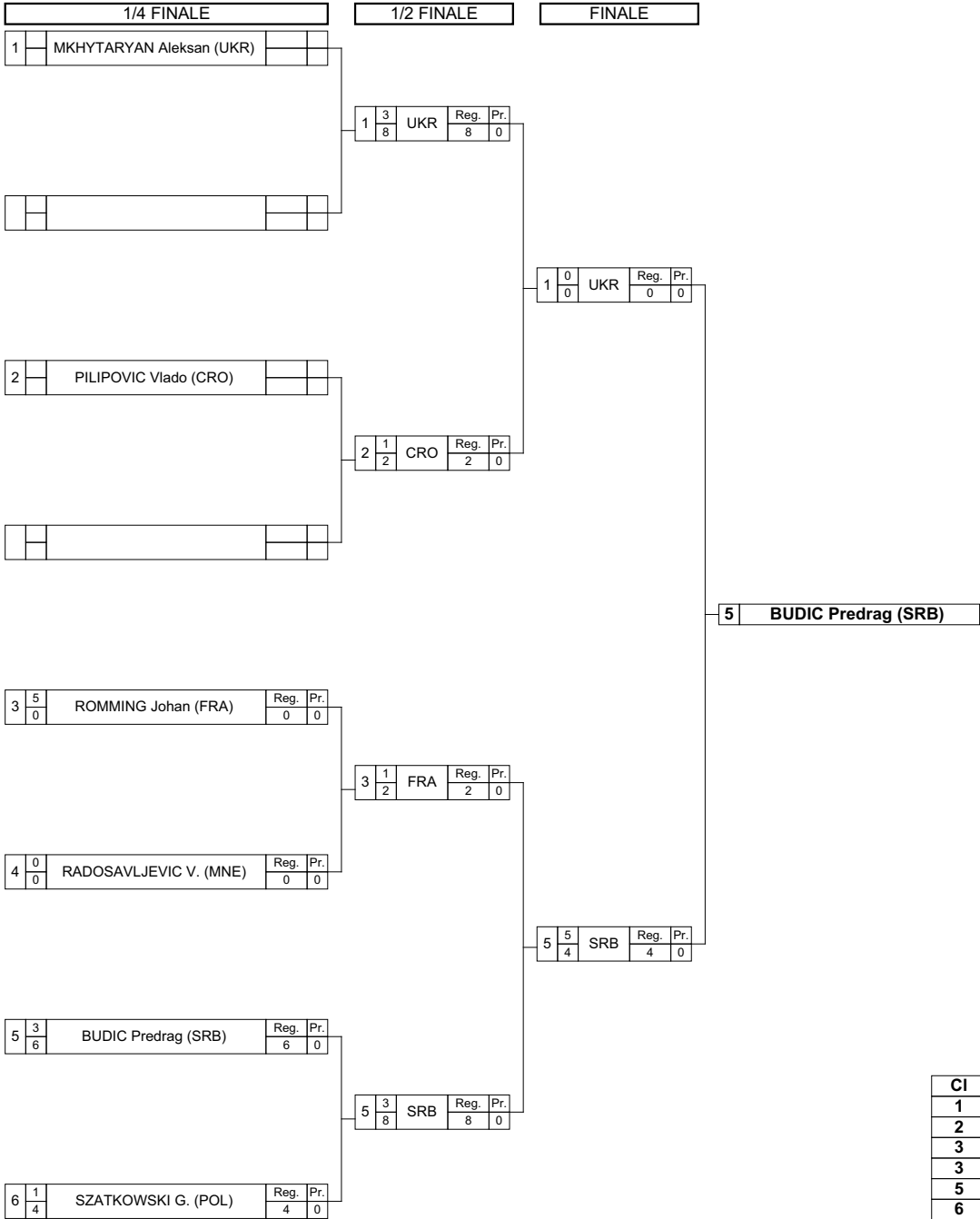

Classement

Cl	Pays	Nom
1	SRB	BUDIC Predrag
2	UKR	MKHYTARYAN Aleksan
3	CRO	PILIPOVIC Vlado
3	POL	SZATKOWSKI Grzegorz
5	FRA	ROMMING Johan
6	MNE	RADOSAVLJEVIC V.

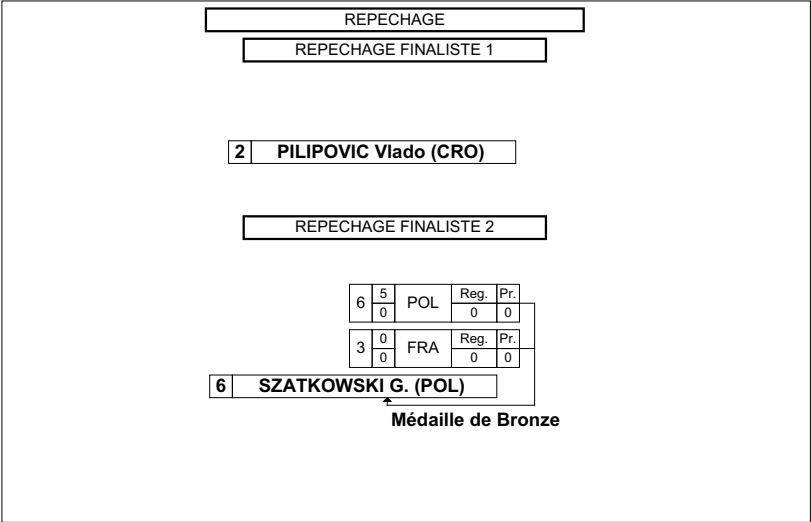



# Feuille de compétition / Competition Sheet

## European Champ. Grappling



STYLE : GI-M Abs kg

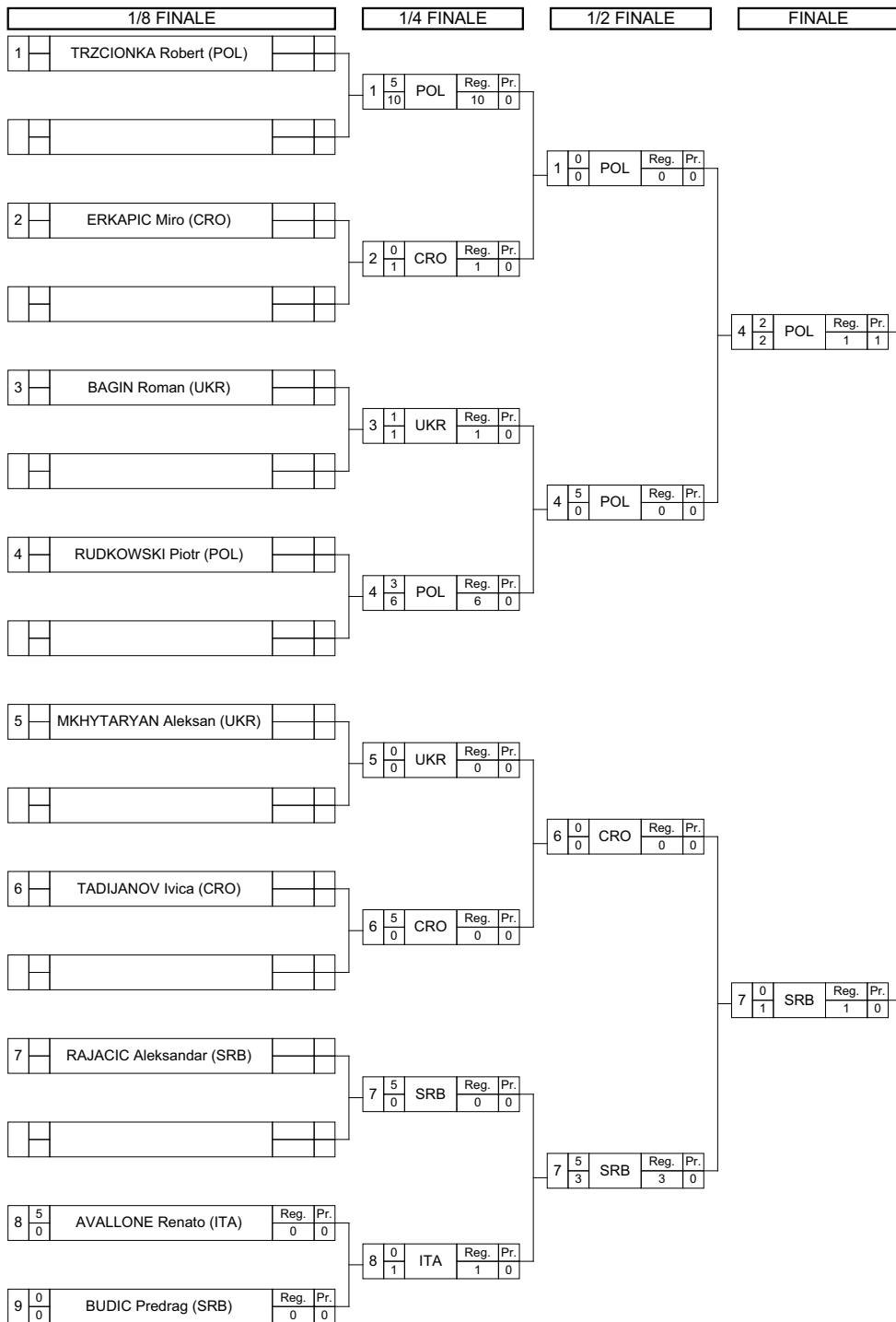

**4 RUDKOWSKI Piotr (POL)**

### Classement

Cl	Pays	Nom
1	POL	RUDKOWSKI Piotr
2	SRB	RAJACIC Aleksandar
3	POL	TRZCIONKA Robert
3	CRO	TADIJANOV Ivica
5	UKR	BAGIN Roman
5	ITA	AVALLONE Renato
7	CRO	ERKAPIC Miro
8	SRB	BUDIC Predrag

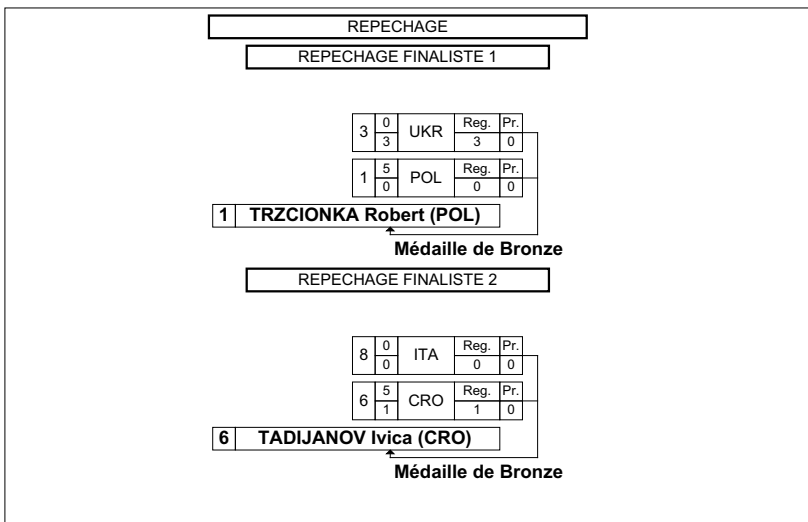





# Feuille de compétition / Competition Sheet

## European Champ. Grappling

STYLE : GI-W 50 kg



### TOUR : 1

1	$\frac{3}{4}$	SOLA Marija (CRO)	Reg	Pr.	1	SOLA Marija (CRO)
			4	0		
2	$\frac{0}{0}$	GALKA Joanna (POL)	Reg	Pr.		
			0	0		
3	$\frac{0}{0}$	ROMANI Marta (ITA)	Reg	Pr.	4	PIGULYAK Svitlana (UKR)
			0	0		
4	$\frac{5}{0}$	PIGULYAK Svitlana (UKR)	Reg	Pr.		
			0	0		

### TOUR : 2

1	$\frac{3}{3}$	SOLA Marija (CRO)	Reg	Pr.	1	SOLA Marija (CRO)
			3	0		
3	$\frac{0}{0}$	ROMANI Marta (ITA)	Reg	Pr.		
			0	0		
2	$\frac{0}{0}$	GALKA Joanna (POL)	Reg	Pr.	4	PIGULYAK Svitlana (UKR)
			0	0		
4	$\frac{3}{3}$	PIGULYAK Svitlana (UKR)	Reg	Pr.		
			3	0		

### TOUR : 3

1	$\frac{5}{0}$	SOLA Marija (CRO)	Reg	Pr.	1	SOLA Marija (CRO)
			0	0		
4	$\frac{0}{0}$	PIGULYAK Svitlana (UKR)	Reg	Pr.		
			0	0		
2	$\frac{3}{2}$	GALKA Joanna (POL)	Reg	Pr.	2	GALKA Joanna (POL)
			2	0		
3	$\frac{0}{0}$	ROMANI Marta (ITA)	Reg	Pr.		
			0	0		

### Classement

Cl	Pays	Nom	Points
1	CRO	SOLA Marija	11
2	UKR	PIGULYAK Svitlana	8
3	POL	GALKA Joanna	3
4	ITA	ROMANI Marta	0



# Feuille de compétition / Competition Sheet

## European Champ. Grappling

STYLE : GI-W 55 kg



### TOUR : 1

1	0	KUZMENKO Tetyana (UKR)	Reg	Pr.	2	PASZKIEWICZ Sandra (POL)
	1		1	0		
2	5	PASZKIEWICZ Sandra (POL)	Reg	Pr.	4	TALVARD Océane (FRA)
	1		1	0		
3	0	OLBERT Elisabeth (AUT)	Reg	Pr.	4	TALVARD Océane (FRA)
	0		0	0		
4	3	TALVARD Océane (FRA)	Reg	Pr.	4	TALVARD Océane (FRA)
	2		2	0		

### TOUR : 2

1	1	KUZMENKO Tetyana (UKR)	Reg	Pr.	3	OLBERT Elisabeth (AUT)
	1		1	0		
3	4	OLBERT Elisabeth (AUT)	Reg	Pr.	4	TALVARD Océane (FRA)
	9		9	0		
2	0	PASZKIEWICZ Sandra (POL)	Reg	Pr.	4	TALVARD Océane (FRA)
	0		0	0		
4	3	TALVARD Océane (FRA)	Reg	Pr.	4	TALVARD Océane (FRA)
	5		5	0		

### TOUR : 3

1	0	KUZMENKO Tetyana (UKR)	Reg	Pr.	4	TALVARD Océane (FRA)
	0		0	0		
4	3	TALVARD Océane (FRA)	Reg	Pr.	4	TALVARD Océane (FRA)
	6		6	0		
2	3	PASZKIEWICZ Sandra (POL)	Reg	Pr.	2	PASZKIEWICZ Sandra (POL)
	6		6	0		
3	0	OLBERT Elisabeth (AUT)	Reg	Pr.	2	PASZKIEWICZ Sandra (POL)
	0		0	0		

### Classement

Cl	Pays	Nom	Points
1	FRA	TALVARD Océane	9
2	POL	PASZKIEWICZ Sandra	8
3	AUT	OLBERT Elisabeth	4
4	UKR	KUZMENKO Tetyana	1



# Feuille de compétition / Competition Sheet

## European Champ. Grappling

STYLE : GI-W 60 kg



**TOUR : 1**

1	5 1	SYNYAVINA V. (UKR)	Reg 1	Pr. 0	1	<b>SYNYAVINA V. (UKR)</b>
2	0 0	KRCMAREVIC Andjela (SRB)	Reg 0	Pr. 0		

**TOUR : 2**

3	5 2	PREISS Irena (POL)	Reg 2	Pr. 0	3	<b>PREISS Irena (POL)</b>
1	0 3	SYNYAVINA V. (UKR)	Reg 3	Pr. 0		

**TOUR : 3**

2	0 1	KRCMAREVIC Andjela (SRB)	Reg 1	Pr. 0	3	<b>PREISS Irena (POL)</b>
3	5 4	PREISS Irena (POL)	Reg 4	Pr. 0		

### Classement

Cl	Pays	Nom	Points
1	POL	PREISS Irena	10
2	UKR	SYNYAVINA Viktoriya	5
3	SRB	KRCMAREVIC Andjela	0



# Feuille de compétition / Competition Sheet

## European Champ. Grappling

STYLE : GI-W 65 kg



**TOUR : 1**

1	5	ZAWODNIK Karolina (POL)	Reg	Pr.	1	ZAWODNIK Karolina (POL)
	4		4	0		
2	0	DAVYDOVA Margaryta (UKR)	Reg	Pr.		
	0		0	0		

### Classement

Cl	Pays	Nom	Points
1	POL	ZAWODNIK Karolina	5
2	UKR	DAVYDOVA Margaryta	0



# Feuille de compétition / Competition Sheet

## European Champ. Grappling

STYLE : GI-W 75 kg

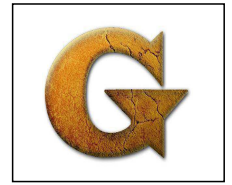

### TOUR : 1

1	5 1	RUYSEN Romy (FRA)	Reg 1	Pr. 0	1	RUYSEN Romy (FRA)
2	0 0	DUDEK Anna (POL)	Reg 0	Pr. 0		

### TOUR : 2

3	0 0	MATEICHUK Galyna (UKR)	Reg 0	Pr. 0	1	RUYSEN Romy (FRA)
1	5 3	RUYSEN Romy (FRA)	Reg 3	Pr. 0		

### TOUR : 3

2	5 6	DUDEK Anna (POL)	Reg 6	Pr. 0	2	DUDEK Anna (POL)
3	0 0	MATEICHUK Galyna (UKR)	Reg 0	Pr. 0		

### Classement

Cl	Pays	Nom	Points
1	FRA	RUYSEN Romy	10
2	POL	DUDEK Anna	5
3	UKR	MATEICHUK Galyna	0

